

## GENERAL-PURPOSE ELECTRICAL CABINET

STAINLESS STEEL 60x40x26

Electrical Cabinets  
General-Purpose Stainless Steel

### FEATURES

- Injection-molded polyurethane gasket.
- Made of 304 stainless steel.
- Electrical grounding screw.
- Quarter-turn zinc-plated plate.
- Stainless steel hardware and galvanized mounting plate.
- Door opening: 120°.

### BENEFITS

- **IP66 protection.**
- Removable door and base plate.
- UL-certified injection-molded gasket.
- Doors with recessed corners to prevent water ingress.
- High corrosion resistance.

### APPLICATIONS

- Used in the food industry, humid environments, and areas with high salinity.



### ISOMETRIC

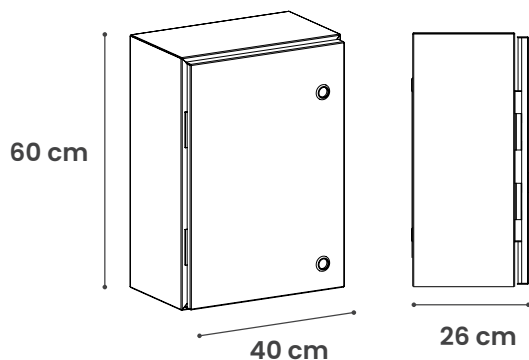

### ESPECIFICACIONES

TYPE	SURFACE-MOUNT
APPLICATION	INDOOR
MATERIAL	304 STAINLESS STEEL
GAUGE	18
MOUNTING PLATE	YES
MOUNTING PLATE MATERIAL	GALVANIZED SHEET
MOUNTING PLATE DIMENSIONS	55X35 CM
MOUNTING PLATE GAUGE	16
SCREWS	STAINLESS STEEL
TYPE OF LOCK	KEY-LOCKING QUARTER-TURN LATCH
NUMBER OF LATCHES	2
HINGED	REINFORCED AND STAINLESS STEEL
SHIPMENT	INJECTED POLYURETHANE
PROTECTION	IP66
WEIGHT	10.6 KG

### CONFIGURATIONS

### CERTIFICATIONS

CODE	DESCRIPTION	H	W	D
2KUGSOAINA604026	GENERAL-PURPOSE ELECTRICAL CABINET 60X40X26	60	40	26



HQ Manufacturing Facility  
Gómez Palacio  
871 750 00 03, 79  
871 750 11 52, 62

Guadalajara Branch  
331 368 80 28  
333 162 08 75

Monterrey Branch  
818 191 99 91  
811 520 08 53

Mérida Branch  
999 445 62 12

Chihuahua  
Sales Office  
614 293 96 54

Mexico City  
Sales Office  
567 004 20 92